

## Spis treści

Table of contents

## SPIS TREŚCI

Table of contents

9.5	<b>Infrmacje ogólne</b> <i>General information</i>	
9.7	<b>Czop mocujący</b> <i>Shank</i>	 CB
9.8	<b>Czop transportowy VDI 3366</b> <i>Lifting stud VDI 3366</i>	 CT
9.9	<b>Śruba z uchem</b> <i>Lifting eye bolt</i>	 SUM
9.10	<b>Śruba z uchem ośmiokątnym</b> <i>Eye bolt</i>	 RS
9.12	<b>Śruba z uchem ośmiokątnym obrotowym</b> <i>Vario-Starpoint</i>	 VRS
9.14	<b>Nakrętka z ośmiokątnym uchem obrotowym</b> <i>Starpoint eye nut</i>	 VRM
9.15	<b>Śruba z uchem obrotowym i uchylnym</b> <i>Lifting Point-VARIO</i>	 VWBG-V
9.17	<b>Ogniwo przegubowe wkręcane ze śrubą</b> <i>Load ring</i>	 VLBG

## Spis treści

Table of contents

9.19	<b>Kołek walcowy</b> <i>Dowel pin</i>		KW
9.22	<b>Kołek walcowy z gwintem</b> <i>Dowel pin with thread</i>		KWG
9.24	<b>Zatrząsk kulkowy</b> <i>Ball lock</i>		ZK
9.24	<b>Zatrząsk</b> <i>Threaded lock</i>		ZR
9.25	<b>Wkręt mocujący</b> <i>Set screw</i>		WK
9.26	<b>Wkręt</b> <i>Hexagon socket set screw</i>		WKA
9.27	<b>Śruba z łbem walcowym</b> <i>Socket head cap screw</i>		SM
9.29	<b>Śruba pasowana</b> <i>Stripper bolt</i>		PSM
9.30	<b>Śruba pasowana z tulejką</b> <i>Stripper bolt with bushing</i>		PST

## Informacje ogólne

General information

### ZALECENIA DOTYCZĄCE UŻYTKOWANIA UCHWYTÓW:

1. Powierzchnia, do której przykręcony będzie uchwyt powinna być płaska. Należy zwrócić też uwagę na obciążenie śruby ockowej. Połączenie gwintowe powinno być odpowiednie do przenoszonego obciążenia i rodzaju transportowanego materiału.

Zaleca się minimalne głębokości gwintu:

- 1 x M\* – dla stali
- 2 x M\* – dla aluminium
- 1,25 x M\* – dla żeliwa
- 2,5 x M\* – dla stopów aluminium i magnezu

\* – średnica gwintu

2. W przypadku stosowania uchwytów łącznie z łańcuchami, pasami i linami nośnymi, należy zwracać uwagę na właściwe ich obciążenie (stosować wyłącznie elementy z atestem)

W czasie użytkowania uchwytów należy sprawdzać czy są one cały czas mocno usadowione oraz zwracać szczególną uwagę na ich zużycie (wygięcia, pęknięcia, ślady korozji itp.)

### 3. ODDZIAŁYWANIE TEMPERATURY

Dopuszczalne obciążenia stosowanych uchwytów należy odpowiednio zredukować, zgodnie z poniższą tabelą:

100° do 200°C minus 15%	212°F to 392°F
200° do 250°C minus 20%	392°F to 482°F
250° do 350°C minus 25%	482°F to 662°F

Nie należy stosować w temperaturach powyżej 350°C (662°F)

### USER INSTRUCTION:

1. Ensure that the bolting surface is flat. See also loading of eyebolts. The threaded connection on the transported load must be suitable for transferring forces and the material construction.

Minimum thread depth recommends:

- 1 x M\* – in steel
- 2 x M\* – in aluminium
- 1,25 x M\* – in cast iron
- 2,5 x M\* – in aluminium-magnesium alloys

\* – thread diameter

2. When using eyebolts with chains, belts, lines make sure they have in appropriate load limits (use only certified products).

Once bolts have been in use for some time check that they firmly seated. Pay special attention to any cracks, bends or signs of corrosion.

### 3.EFFECT OF TEMPERATURE:

For lifting points for bolt on the working load limits have to be reduced according to following table:

100° to 200°C minus 15%	212°F to 392°F
200° to 250°C minus 20%	392°F to 482°F
250° to 350°C minus 25%	482°F to 662°F

Temperatures above 350°C (662°F) are not permitted



**Czop mocujący**

Shank

**CB**

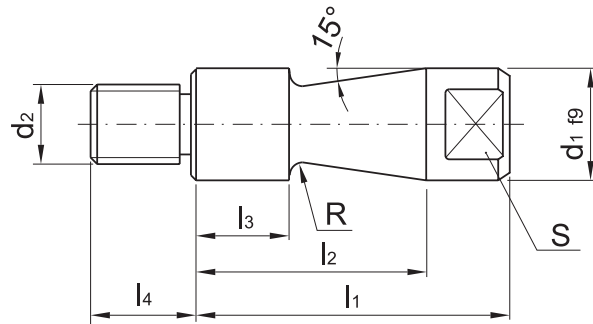

d1	d2	l1	l2	S	l3	l4	R	NR KAT.
20	M16x1,5	40	28	14	14	13	6	CB-2028
25	M20x1,5	45	32	19	16	16		CB-2532
32	M24x2	50	37	24	17	19	8	CB-3237
40	M30x2	72	53	32	28		12	CB-4053
50	M42x2	80	56	41				CB-5056

**Czop transportowy VDI 3366**

Lifting stud VDI 3366

**CT**

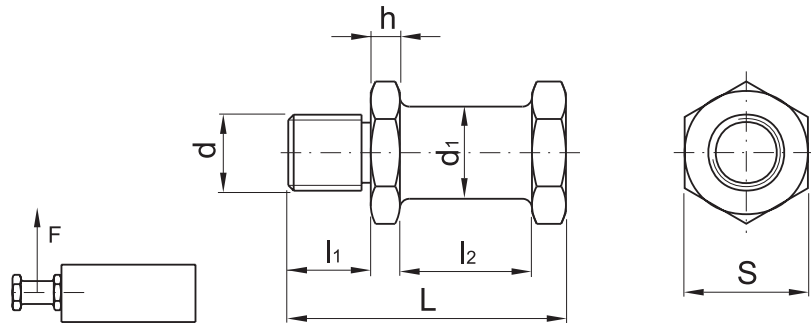

d	l <sub>1</sub>	l <sub>2</sub>	L	d <sub>1</sub>	h	S	F <sub>max</sub> [kg]	NR KAT.
<b>M16</b>	22	16	50	16	6	27	320	<b>CT-16</b>
<b>M20</b>	25	20	60	20	7,5	32	500	<b>CT-20</b>
<b>M24</b>	32	25	78	25	10,5	36	1000	<b>CT-24</b>
<b>M30</b>	40	32	95	32	11,5	41	1500	<b>CT-30</b>
<b>M36</b>	50	40	118	40	14	50	2500	<b>CT-36</b>

**Śruba z uchem**

Lifting eye bolt

**SUM**

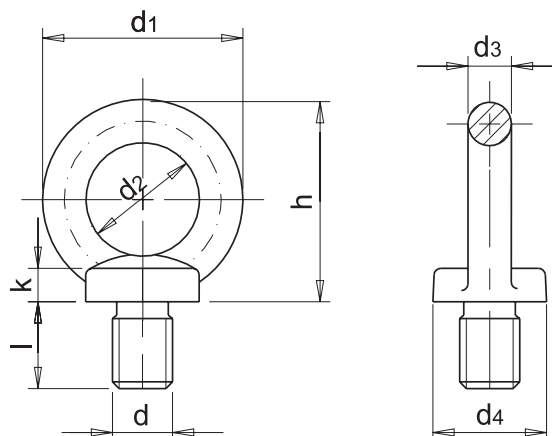

NR KAT	SUM-08	SUM-10	SUM-12	SUM-16	SUM-20	SUM-24	SUM-30	SUM-36
<b>d</b>	M8	M10	M12	M16	M20	M24	M30	M36
<b>d1</b>	36	45	54	63	71	90	108	126
<b>d2</b>	20	25	30	35	40	50	60	70
<b>d3</b>	8	10	12	14	16	20	24	28
<b>d4</b>	20	25	30	35	40	50	60	70
<b>h</b>	36	45	53	62	70	90	109	128
<b>k</b>	6	8	10	12	14	16	22	27
<b>l</b>	13	17	20.5	27	30	36	45	54

Q max. [kg]	SUM-08	SUM-10	SUM-12	SUM-16	SUM-20	SUM-24	SUM-30	SUM-36
	140	230	340	700	1200	1800	3200	4600
	100	170	240	500	860	1290	2300	3300

Na specjalne zamówienie dostarczymy śruby z uchem – calowe.  
Lifting eye bolts with thread inch on request.

## Śruba z uchem ośmiokątnym

Eye bolt

**RS**

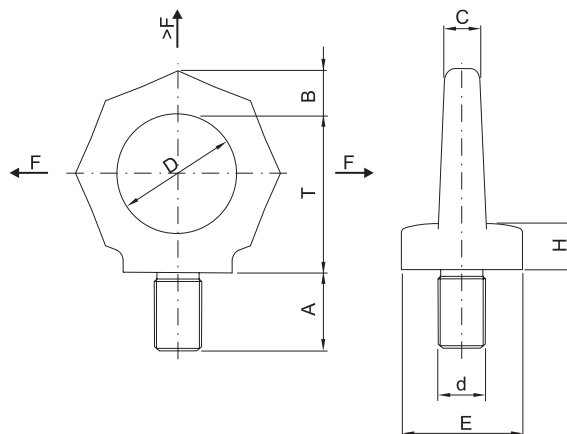

**Uwaga:**  
F – obciążenie dopuszczalne dla każdego punktu zaczepienia.

Note:  
F – working load limit carrying capacity of each lifting point.









NR KAT. Order No.	Typ Type	F [t]	A	B	C	D	E	H	d	T	waga weight [kg]
61401	RS-M6	0,1	12	11	10	25	25	11	M6	34	0,1
61402	RS-M8	0,2	12	11	10	25	25	11	M8	34	0,1
56397	RS-M10	0,25	15	11	10	25	25	11	M10	34	0,1
56398	RS-M12	0,4	18	13	12	30	30	12	M12	41	0,2
56403	RS-M14	0,75	21	15	14	35	35	13	M14	48	0,25
56404	RS-M16	1	24	15	14	35	35	13	M16	48	0,3
56407	RS-M20	1,5	30	17	16	40	40	16	M20	55	0,45
56408	RS-M24	2	36	21	20	50	50	20	M24	70	0,7
56409	RS-M30	3	45	26	24	60	60	25	M30	85	1,6
56954	RS-M36	4	54	43	38	90	100	37	M36	130	6,0
56955	RS-M42	6	63	43	38	90	100	37	M42	130	6,2
56956	RS-M48	8	67	43	38	90	100	37	M48	130	6,4



## Śruba z uchem ośmiokątnym

Eye bolt

# RS

Sposób zawieszania Method of lift										
Ilość punktów zawieszania Number of legs	1	1	2	2	2	2	2	3 - 4	3 - 4	3 - 4
Kąt pochyleńia <math>\beta</math> Angle of inclination <math>< \beta</math>	0°	90°	0°	90°	0°- 45°	45°- 60°	niesymetr. unsymmetr.	0°- 45°	45°- 60°	niesymetr. unsymmetr.
NR KAT. Order No.	Typ Type	Max. waga „G” [ t ] dla wszystkich punktów zaczepienia w zależności od sposobu zawieszania Max. weight of load "G" [ t ] for all power point types with different sling methods								
61401	RS-M6	0,4	0,1	0,8	<p><b>W tym zakresie zaleca się stosowanie elementów transportowych typu VRS z możliwością regulacji kierunku obciążania.</b></p> <p><i>In this range we recommend use the VRS type that is adjustable in the direction of pull!</i></p>					
61402	RS-M8	0,8	0,2	1,6						
56397	RS-M10	1	0,25	2						
56398	RS-M12	1,6	0,4	3,2						
56403	RS-M14	3	0,75	6						
56404	RS-M16	4	1	8						
56407	RS-M20	6	1,5	12						
56408	RS-M24	8	2	16						
56409	RS-M30	12	3	24						
56954	RS-M36	16	4	32						
56955	RS-M42	24	6	48						
56956	RS-M48	32	8	64						

# Śruba z uchem ośmiokątnym obrotowym

Vario-Starpoint

# VRS

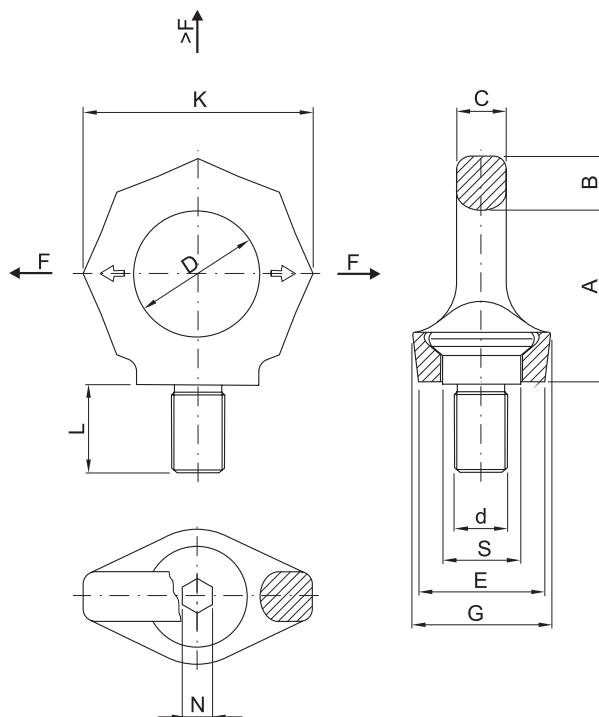

**Uwaga:**  
F – obciążenie dopuszczalne dla każdego punktu zaczepienia.

Note:  
F – working load limit carrying capacity of each lifting point.

bez klucza without key		z kluczem with key		F [t]	A	B	C	D	E	G	K	L	d	N	S	opako- wanie packing unit
NR KAT. Order No.	Typ Type	NR KAT. Order No.	Typ Type													
7100554	VRS-M8	8500911	VRS-F-M8	0,3	34	11	8,5	25	25	28	47	12	M8	6	16	20
7100555	VRS-M10	7104029	VRS-F-M10	0,4	34	11	8,5	25	25	28	47	15	M10	6	15	20
7100556	VRS-M12	7101313	VRS-F-M12	0,75	42	13	10	30	30	34	56	18	M12	8	18	20
7100558	VRS-M16	7101314	VRS-F-M16	1,5	49	15	14	35	35	40	65	24	M16	10	22	10
7100559	VRS-M20	7101315	VRS-F-M20	2,3	57	17	16	40	40	50	75	30	M20	12	27,5	10
7100560	VRS-M24	7101316	VRS-F-M24	3,2	69	21	19	48	48	60	90	36	M24	14	33	10
7100561	VRS-M30	7101317	VRS-F-M30	4,5	86	26	24	60	60	75	112	45	M30	17	41,5	4
7984198	VRS-M36	7984201	VRS-F-M36	7	103	32	29	72	72	90	135	54	M36	22	49,5	1
7984199	VRS-M42	7984202	VRS-F-M42	9	120	38	34	82	82	105	158	63	M42	24	58	1
7984200	VRS-M48	7984203	VRS-F-M48	12	137	43	38	94	100	120	180	72	M48	27	66	1

# Śruba z uchem ośmiokątnym obrotowym

Vario-Starpoint

# VRS

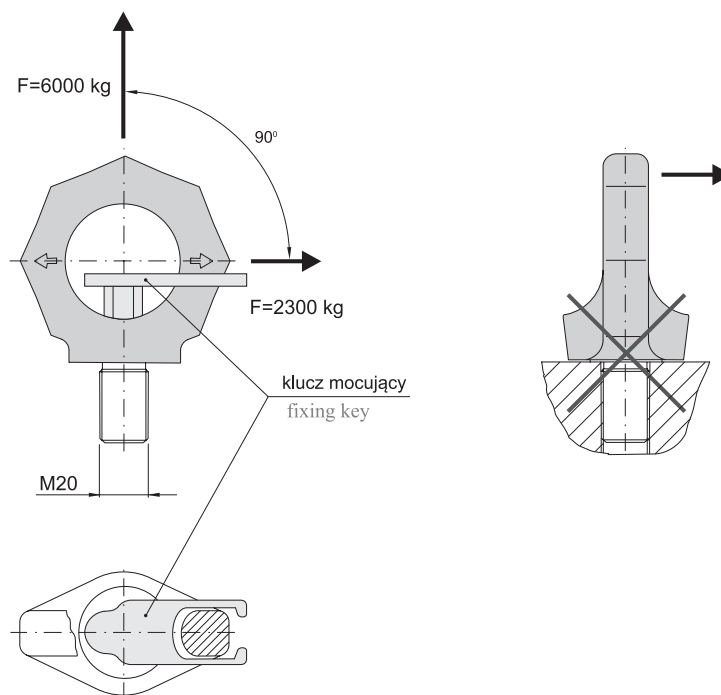

Sposób zawieszania Method of lift											
Ilość punktów zawieszania Number of legs		1	1	2	2	2	2	2	3 - 4	3 - 4	3 - 4
Kąt pochylenia <math>\beta</math> Angle of inclination <math>\beta</math>		0°	90°	0°	90°	0°- 45°	45°- 60°	niesymetr. unsymmetr.	0°- 45°	45°- 60°	niesymetr. unsymmetr.
NR KAT. Order No.	Typ Type	Max. waga „G” [ t ] dla wszystkich punktów zaczepienia w zależności od sposobu zawieszania Max. weight of load “G” [ t ] for all power point types with different sling methods									
7100554	VRS-M8	1	0,3	2	0,6	0,56	0,3	0,3	0,6	0,6	0,3
7100555	VRS-M10	1	0,4	2	0,8	0,56	0,4	0,4	0,8	0,6	0,4
7100556	VRS-M12	2	0,7	4	1,5	1	0,7	0,7	1,5	1,1	0,7
7100558	VRS-M16	4	1,5	8	3	2,1	1,5	1,5	3,1	2,2	1,5
7100559	VRS-M20	6	2,3	12	4,6	3,2	2,3	2,3	4,8	3,4	2,3
7100560	VRS-M24	8	3,2	16	6,4	4,5	3,2	3,2	6,7	4,8	3,2
7100561	VRS-M30	12	4,5	24	9	6,3	4,5	4,5	9,4	6,7	4,5
7984198	VRS-M36	16	7	32	14	9,8	7	7	14,7	10,5	7
7984199	VRS-M42	24	9	48	18	12,6	9	9	18,9	13,5	9
7984200	VRS-M48	32	12	64	24	16,8	12	12	25	18	12

# Nakrętka z ośmiokątnym uchem obrotowym

Starpoint eye nut

# VRM

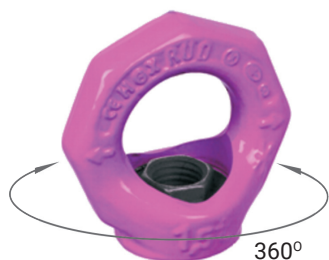

**Uwaga:**  
**F – obciążenie dopuszczalne dla każdego punktu zaczepienia.**

Note:  
F – working load limit carrying capacity of each lifting point.

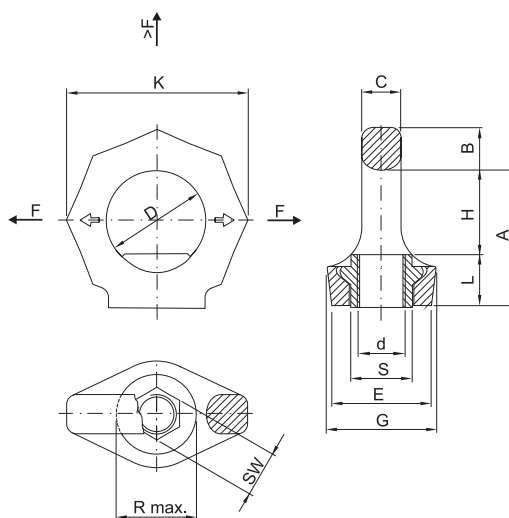

NR KAT. Order No.	Typ Type	F [t]	A	B	C	D	E	G	H	K	L	d	R	S	SW	waga weight [kg]
7992989	VRM-M8	0,4	34	11	8,5	25	25	28	20	47	14	M8	20	16	12	0,1
7990311	VRM-M10	0,4	34	11	8,5	25	25	28	20	47	14	M10	20	16	12	0,1
7990312	VRM-M12	0,75	42	13	10	30	30	34	25	56	17	M12	24	20	14	0,2
7990314	VRM-M16	1,5	51	15	14	35	35,5	40	30	65	21	M16	30	22	19	0,3
7990315	VRM-M20	2,3	57	17	16	40	40	50	34	75	23	M20	37	29	24	0,5
7990316	VRM-M24	3,2	69	21	19	48	50	60	40	90	29	M24	45	35	30	0,9
7993008	VRM-M30	4,5	86	26	24	60	60	75	52	112	34	M30	56	44	36	1,7

Sposób zawieszania Method of lift										
Ilość punktów zawieszania Number of legs	1	1	2	2	2	2	2	3 - 4	3 - 4	3 - 4
Kąt pochylenia < β Angle of inclination < β	0°	90°	0°	90°	0°- 45°	45°- 60°	niesymetr. unsymmetr.	0°- 45°	45°- 60°	niesymetr. unsymmetr.

NR KAT. Order No.	Typ Type	Max. waga „G” [t] dla wszystkich punktów zaczepienia w zależności od sposobu zawieszania Max. weight of load “G” [t] for all power point types with different sling methods									
7992989	VRM-M8	1,0	0,4	2,0	0,8	0,56	0,4	0,4	0,8	0,6	0,4
7990311	VRM-M10	1,0	0,4	2,0	0,8	0,56	0,4	0,4	0,8	0,6	0,4
7990312	VRM-M12	2,0	0,7	4,0	1,5	1,0	0,7	0,7	1,5	1,1	0,7
7990314	VRM-M16	4,0	1,5	8,0	3,0	2,1	1,5	1,5	3,1	2,2	1,5
7990315	VRM-M20	6,0	2,3	12,0	4,6	3,2	2,3	2,3	4,8	3,4	2,3
7990316	VRM-M24	8,0	3,2	16,0	6,4	4,5	3,2	3,2	6,7	4,8	3,2
7993008	VRM-M30	12,0	4,5	24,0	9,0	6,3	4,5	4,5	9,4	6,7	4,5

# Śruba z uchem obrotowym i uchylnym

Lifting Point – VARIO

# VWBG-V

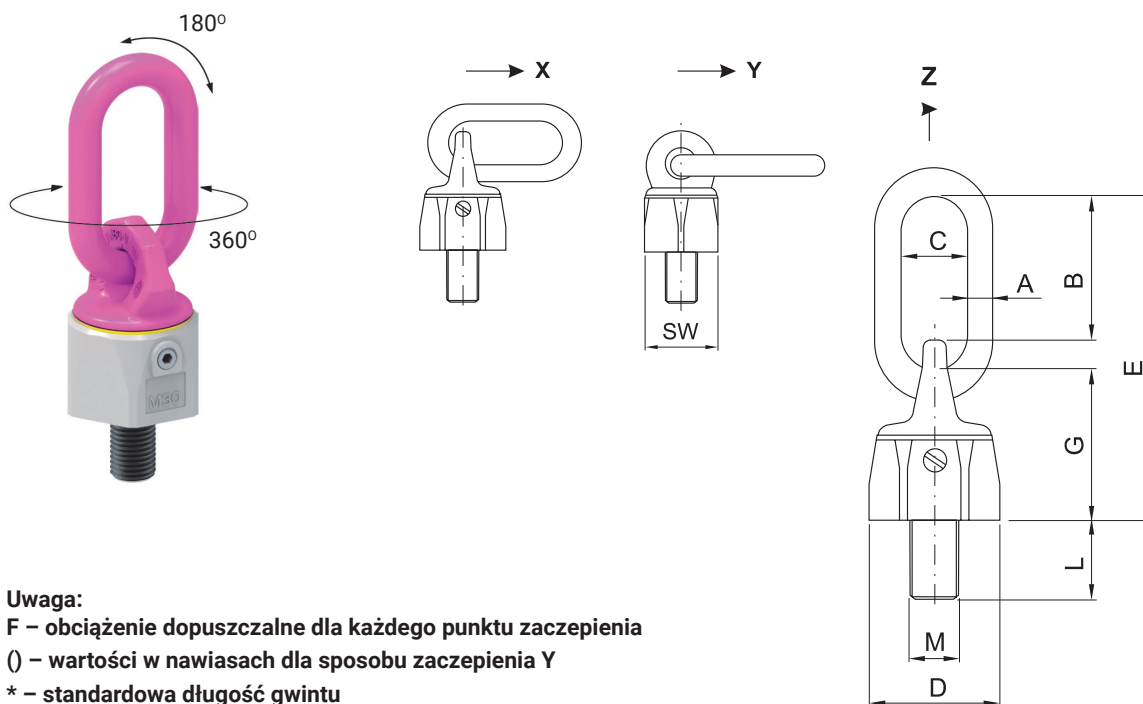

**Uwaga:**

**F** – obciążenie dopuszczalne dla każdego punktu zaczepienia

**()** – wartości w nawiasach dla sposobu zaczepienia **Y**

**\*** – standardowa długość gwintu

**\*\*** – opcjonalna długość gwintu (w zakresie do długości **L max.**) – przy zamawianiu śrub o wymiarach niestandardowych, należy określić jej długość (**L**)

*Note:*

*F* – working load limit carrying capacity of each lifting point

*()* – the values in the brackets for engage method **Y**

*\** – standard length of bolt thread

*\*\** – optional length of bolt thread (*L max. range only*) – when ordering optional one please specify the length (*L*)

NR KAT. Order No.	Typ Type	F [t]	A	B	C	D	SW	L*	L** max	G	M	E	waga weight [kg]
7103720	VWBG-V 0,3-M8	0,3 (0,4)	8	33	29	33	28	13	102	36	M8	76	0,25
7103715	VWBG-V 0,45-M10	0,45 (0,6)	8	33	29	36	30	17	122	38	M10	78	0,3
7100180	VWBG-V 0,6-M12	0,6 (0,75)	10	51	35	42	36	21	140	45	M12	105	0,4
7100430	VWBG-V 1,3-M16	1,3 (1,5)	13	47	38	48	41	25	180	54	M16	114	0,6
7100800	VWBG-V 2,0-M20	2,0 (2,5)	13	56	35	64	55	33	223	65	M20	135	1,1
7100640	VWBG-V 3,5-M24	3,5 (4,0)	18	68	40	81	70	40	255	87	M24	172	2,7
7100650	VWBG-V 5,0-M30	5,0 (6,0)	22	93	50	99	85	50	330	105	M30	220	5,5

**Śruba z uchem obrotowym i uchylnym**
*Lifting Point – VARIO*
**VWBG-V**

Sposób zawieszania Method of lift											
Ilość punktów zawieszania Number of legs		1	1	2	2	2	2	2	3 - 4	3 - 4	3 - 4
Kąt pochylenia <math>\beta</math> Angle of inclination <math>< \beta</math>		0°	90°	0°	90°	0°- 45°	45°- 60°	niesymetr. <i>unsymmetr.</i>	0°- 45°	45°- 60°	niesymetr. <i>unsymmetr.</i>
NR KAT. Order No.	Typ Type	Max. waga „G” [ t ] dla wszystkich punktów zaczepienia w zależności od sposobu zawieszania <i>Max. weight of load "G" [ t ] for all power point types with different sling methods</i>									
7103720	VWBG-V 0,3-M8	0,6	0,3 (0,4)	1,2	0,6 (0,8)	0,4	0,3	0,3	0,6	0,4	0,3
7103715	VWBG-V 0,45-M10	0,9	0,45 (0,6)	1,8	0,9 (1,2)	0,6	0,4	0,4	0,9	0,6	0,4
7100180	VWBG-V 0,6-M12	1,2	0,6 (0,7)	2,4	1,2 (1,5)	0,8	0,6	0,6	1,2	0,9	0,6
7100430	VWBG-V 1,3-M16	2,6	1,3 (1,5)	5,2	2,6 (3)	1,8	1,3	1,3	2,7	1,9	1,3
7100800	VWBG-V 2,0-M20	4	2 (2,5)	8	4 (5)	2,8	2	2	4,2	3	2
7100640	VWBG-V 3,5-M24	7	3,5 (4)	14	7 (8)	4,9	3,5	3,5	7,3	5,2	3,5
7100650	VWBG-V 5,0-M30	10	5 (6)	20	10 (12)	7	5	5	10,5	7,5	5

**Ogniwo przegubowe wkręcane ze śrubą**

Load ring

**VLBG**

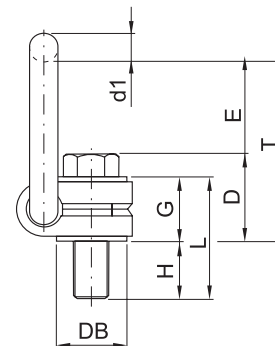
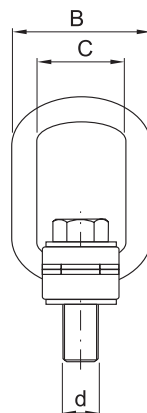

**Uwaga:**

- F – obciążenie dopuszczalne dla każdego punktu zaczepienia
- \* – standardowe wymiary śruby
- \*\* – opcjonalne wymiary śruby (w zakresie do długości L max. / H max.) - przy zamawianiu śrub o wymiarach niestandardowych, należy określić jej długość (L)

**Note:**



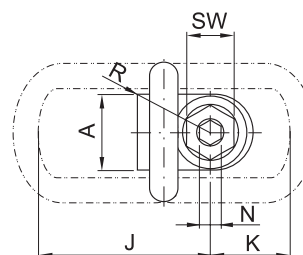





- F – working load limit/ carrying capacity of each lifting point
- \* – standard dimension of bolt
- \*\* – optional dimension of bolt on request (L max. / H max. range only) ordering optional one please specify the length (L)



NR KAT. Order No.	Typ Type	F [t]	A	B	C	D	E	d	d1	G	waga weight [kg]
8504651	VLBG 0,3t M8	0,3	30	54	34	35	40	M8	10	29	0,3
8504652	VLBG 0,63t M10	0,63	30	54	34	36	39	M10	10	29	0,32
8504653	VLBG 1t M12	1	32	54	34	37	38	M12	10	29	0,33
8504655	VLBG 1,5t M16	1,5	33	56	36	46	39	M16	13,5	36	0,55
8504657	VLBG 2,5t M20	2,5	50	82	54	55	55	M20	16,5	43	1,3
8504659	VLBG 4t M24	4	50	82	54	58	66	M24	18	43	1,5
7983658	VLBG 4t M27	4	60	103	65	78	69	M27	22,5	61	3,1
8504661	VLBG 5t M30	5	60	103	65	80	67	M30	22,5	61	3,1
8500829	VLBG 7t M36	7	60	103	65	72	74	M36	22,5	55	3,3
7983553	VLBG 8t M36	8	77	122	82	100	97	M36	26,5	77	5,8
7983554	VLBG 10t M42	10	77	122	82	103	94	M42	26,5	77	6,4
7982966	VLBG 15t M42	15	95	156	100	113	109	M42	36	87	11,2
7982967	VLBG 20t M48	20	95	156	100	117	105	M48	36	87	11,6

**Ogniwo przegubowe wkręcane ze śrubą**
*Load ring*
**VLBG**

NR KAT. Order No.	Typ Type	H*	H** max.	J	K	L*	L** max.	N	SW	R	T	DB
8504651	VLBG 0,3t M8	11	76	75	45	40	105	5	13	32	75	24
8504652	VLBG 0,63t M10	16	96	75	45	45	125	6	17	32	75	24
8504653	VLBG 1t M12	21	116	75	45	50	145	8	19	32	75	26
8504655	VLBG 1,5t M16	24	149	87	47	60	185	10	24	38	85	30
8504657	VLBG 2,5t M20	32	187	113	64	75	230	12	30	48	110	45
8504659	VLBG 4t M24	37	222	130	78	80	265	14	36	48	125	45
7983658	VLBG 4t M27	39	–	151	80	100	–	–	41	67	147	60
8504661	VLBG 5t M30	49	279	151	80	110	340	17	46	67	147	60
8500829	VLBG 7t M36	52	–	151	80	107	–	–	55	67	146	60
7983553	VLBG 8t M36	63	223	205	110	140	300	22	55	85	197	70
7983554	VLBG 10t M42	73	273	205	110	150	350	24	65	85	197	70
7982966	VLBG 15t M42	63	263	230	130	150	350	24	65	100	222	85
7982967	VLBG 20t M48	73	303	230	130	160	390	27	75	100	222	95

Sposób zawieszania Method of lift											
Ilość punktów zawieszenia Number of legs	1	1	2	2	2	2	2	3 - 4	3 - 4	3 - 4	
Kąt pochylenia <math>\alpha</math> Angle of inclination <math>\alpha</math>	0°	90°	0°	90°	0°- 45°	45°- 60°	niesymetr. unsymmetr.	0°- 45°	45°- 60°	niesymetr. unsymmetr.	
NR KAT. Order No.	Typ Type	Max. waga „G” [t] dla wszystkich punktów zaczepienia w zależności od sposobu zawieszania Max. weight of load “G” [t] for all power point types with different sling methods									
8504651	VLBG 0,3t M8	0,3	0,3	0,6	0,6	0,4	0,3	0,3	0,6	0,4	0,3
8504652	VLBG 0,63t M10	0,6	0,6	1,2	1,2	0,8	0,6	0,6	1,3	0,9	0,6
8504653	VLBG 1t M12	1	1	2	2	1,4	1	1	2,1	1,5	1
8504655	VLBG 1,5t M16	1,5	1,5	3	3	2,1	1,5	1,5	3,1	2,2	1,5
8504657	VLBG 2,5t M20	2,5	2,5	5	5	3,5	2,5	2,5	5,2	3,7	2,5
8504659	VLBG 4t M24	4	4	8	8	5,6	4	4	8,4	6	4
7983658	VLBG 4t M27	4	4	8	8	5,6	4	4	8,4	6	4
8504661	VLBG 5t M30	5	5	10	10	7	5	5	10,5	7,5	5
8500829	VLBG 7t M36	7	7	14	14	9,8	7	7	14,7	10,4	7
7983553	VLBG 8t M36	8	8	16	16	11,2	8	8	16,8	12	8
7983554	VLBG 10t M42	10	10	20	20	14	10	10	21	15	10
7982966	VLBG 15t M42	15	15	30	30	21	15	15	31,5	22,5	15
7982967	VLBG 20t M48	20	20	40	40	28	20	20	42	30	20



**Kotek walcowy**

Dowel pin

**KW**

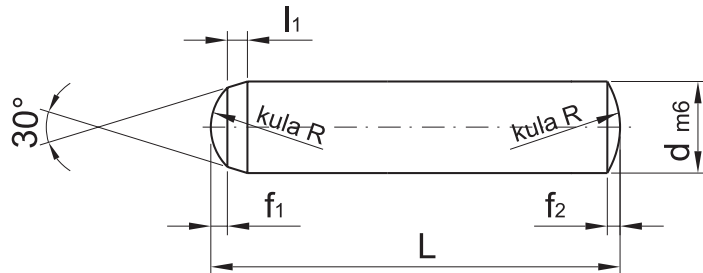

Hartowany  
Hardened **60±2 HRC**

d	f1	f2	l1	R	L	NR KAT.
1	0,08	0,15	0,4	1	8	KW-010008
					10	KW-010010
					12	KW-010012
1,5	0,12	0,23	0,5	1,6	8	KW-015008
					10	KW-015010
					12	KW-015012
					14	KW-015014
					16	KW-015016
2	0,18	0,3	0,6	2	6	KW-020006
					8	KW-020008
					10	KW-020010
					12	KW-020012
					14	KW-020014
					16	KW-020016
					18	KW-020018
					20	KW-020020
					24	KW-020024
2,5	0,25	0,4	0,7	2,5	6	KW-025006
					8	KW-025008
					10	KW-025010
					12	KW-025012
					14	KW-025014
					16	KW-025016
					18	KW-025018
					20	KW-025020
					24	KW-025024
					28	KW-025028
32	KW-025032					

d	f1	f2	l1	R	L	NR KAT.
3	0,3	0,45	0,8	3	6	KW-030006
					8	KW-030008
					10	KW-030010
					12	KW-030012
					14	KW-030014
					16	KW-030016
					18	KW-030018
					20	KW-030020
					24	KW-030024
					28	KW-030028
4	0,4	0,6	1	4	32	KW-030032
					36	KW-030036
					40	KW-030040
					45	KW-030045
					6	KW-040006
					8	KW-040008
					10	KW-040010
					12	KW-040012
					14	KW-040014
					16	KW-040016
					18	KW-040018
					20	KW-040020
					24	KW-040024
					28	KW-040028
5	0,5	0,75	1,2	5	32	KW-040032
					36	KW-040036
					40	KW-040040
					45	KW-040045
					50	KW-040050
					55	KW-040055
					60	KW-040060
					8	KW-050008
					10	KW-050010

**Uwaga: Inne wymiary i tolerancje na specjalne zamówienie.**

Note: Other dimensions and tolerances on request only.

Zastrzegamy sobie prawo do zmian bez uprzedzenia. Zawsze sprawdzaj aktualność katalogu na stronie [www.proplastica.pl](http://www.proplastica.pl)  
We reserve the right to amend this catalogue without notice. Always check [www.proplastica.pl](http://www.proplastica.pl) for latest updates.

**Kołek walcowy**

Dowel pin

**KW**

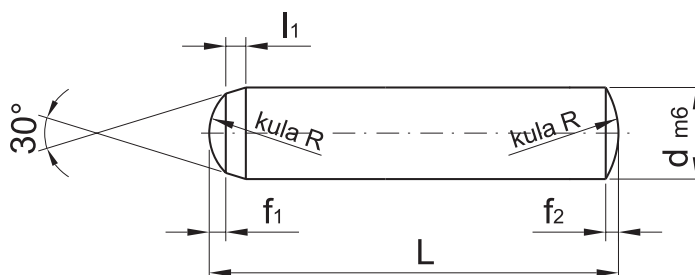

Hartowany  
Hardened 60±2 HRC

d	f1	f2	l1	R	L	NR KAT.
5	0,5	0,75	1,2	5	12	KW-050012
					14	KW-050014
					16	KW-050016
					18	KW-050018
					20	KW-050020
					24	KW-050024
					28	KW-050028
					32	KW-050032
					36	KW-050036
					40	KW-050040
					45	KW-050045
					50	KW-050050
					55	KW-050055
					60	KW-050060
6	0,6	0,9	1,5	6	8	KW-060008
					10	KW-060010
					12	KW-060012
					14	KW-060014
					16	KW-060016
					18	KW-060018
					20	KW-060020
					24	KW-060024
					28	KW-060028
					32	KW-060032
					36	KW-060036
					40	KW-060040
					45	KW-060045
					50	KW-060050
55	KW-060055					
60	KW-060060					

d	f1	f2	l1	R	L	NR KAT.
8	0,8	1,2	1,8	8	10	KW-080010
					12	KW-080012
					14	KW-080014
					16	KW-080016
					18	KW-080018
					20	KW-080020
					24	KW-080024
					28	KW-080028
					32	KW-080032
					36	KW-080036
					40	KW-080040
					45	KW-080045
					50	KW-080050
					55	KW-080055
10	1	1,5	2	10	60	KW-080060
					70	KW-080070
					80	KW-080080
					90	KW-080090
					100	KW-080100
					16	KW-100016
					18	KW-100018
					20	KW-100020
					24	KW-100024
					28	KW-100028
					32	KW-100032
					36	KW-100036
					40	KW-100040
					45	KW-100045
50	KW-100050					
55	KW-100055					

Uwaga: Inne wymiary i tolerancje na specjalne zamówienie.

Note: Other dimensions and tolerances on request only.

Zastrzegamy sobie prawo do zmian bez uprzedzenia. Zawsze sprawdzaj aktualność katalogu na stronie www.proplastica.pl  
We reserve the right to amend this catalogue without notice. Always check www.proplastica.pl for latest updates.

**Kotek walcowy**

Dowel pin

**KW**

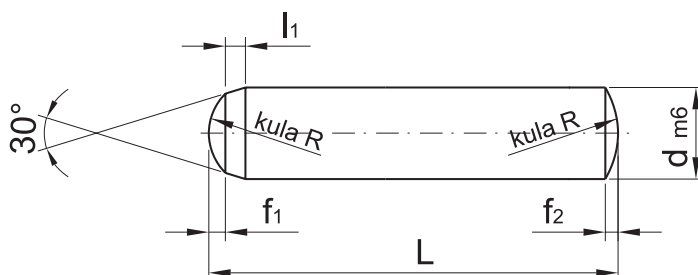

Hartowany  
Hardened **60±2 HRC**

d	f1	f2	l1	R	L	NR KAT.
10	1	1,5	2	10	55	KW-100060
					70	KW-100070
					80	KW-100080
					90	KW-100090
					100	KW-100100
					120	KW-100120
12	1,3	1,8	2,5	12	20	KW-120020
					24	KW-120024
					28	KW-120028
					32	KW-120032
					36	KW-120036
					40	KW-120040
					45	KW-120045
					50	KW-120050
					55	KW-120055
					60	KW-120060
					70	KW-120070
					80	KW-120080
					90	KW-120090
					100	KW-120100
14	1,3	2	2,5	16	36	KW-140036
					40	KW-140040
					45	KW-140045
					50	KW-140050
					55	KW-140055

d	f1	f2	l1	R	L	NR KAT.
14	1,3	2	2,5	16	60	KW-140060
					70	KW-140070
					80	KW-140080
					90	KW-140090
					100	KW-140100
					120	KW-140120
16	1,7	2,5	3	16	40	KW-160040
					45	KW-160045
					50	KW-160050
					55	KW-160055
					60	KW-160060
					70	KW-160070
					80	KW-160080
					90	KW-160090
					100	KW-160100
					120	KW-160120
20	2	3	4,0	20	140	KW-160140
					55	KW-200055
					60	KW-200060
					70	KW-200070
					80	KW-200080
					90	KW-200090
					100	KW-200100
120	KW-200120					
140	KW-200140					

**Uwaga: Inne wymiary i tolerancje na specjalne zamówienie.**

Note: Other dimensions and tolerances on request only.

**Kołek walcowy z gwintem**

Dowel pin with thread

**KWG**

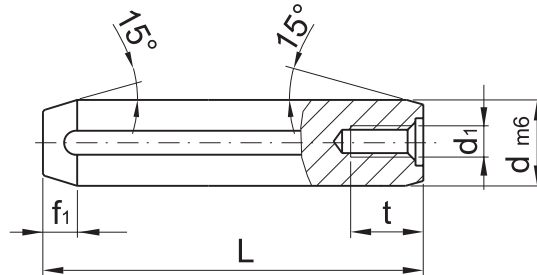

Hartowany  
Hardened 60±2 HRC

d	f1	d1	t	L	NR KAT.
6	2,1	M4	6	16	KWG-06016
				18	KWG-06018
				20	KWG-06020
				24	KWG-06024
				28	KWG-06028
				32	KWG-06032
				36	KWG-06036
				40	KWG-06040
				45	KWG-06045
				50	KWG-06050
				55	KWG-06055
				60	KWG-06060
8	2,6	M5	8	20	KWG-08020
				24	KWG-08024
				28	KWG-08028
				32	KWG-08032
				36	KWG-08036
				40	KWG-08040
				45	KWG-08045
				50	KWG-08050
				55	KWG-08055
				60	KWG-08060
				70	KWG-08070
				80	KWG-08080
90	KWG-08090				
100	KWG-08100				
10	3	M6	10	24	KWG-10024
				28	KWG-10028
				32	KWG-10032
				36	KWG-10036
				40	KWG-10040

d	f1	d1	t	L	NR KAT.				
10	3	M6	10	45	KWG-10045				
				50	KWG-10050				
				55	KWG-10055				
				60	KWG-10060				
				70	KWG-10070				
				80	KWG-10080				
				90	KWG-10090				
				100	KWG-10100				
				12	3,8	M6	10	28	KWG-12028
								32	KWG-12032
40	KWG-12040								
45	KWG-12045								
50	KWG-12050								
55	KWG-12055								
60	KWG-12060								
70	KWG-12070								
80	KWG-12080								
90	KWG-12090								
13	3,8	M6	12	100	KWG-12100				
				120	KWG-12120				
				40	KWG-13040				
				50	KWG-13050				
				60	KWG-13060				
				70	KWG-13070				
				80	KWG-13080				
				100	KWG-13100				
				14	4	M8	12	32	KWG-14032
								36	KWG-14036
40	KWG-14040								
45	KWG-14045								
50	KWG-14050								
55	KWG-14055								
60	KWG-14060								

## Kołek walcowy z gwintem

Dowel pin with thread

# KWG

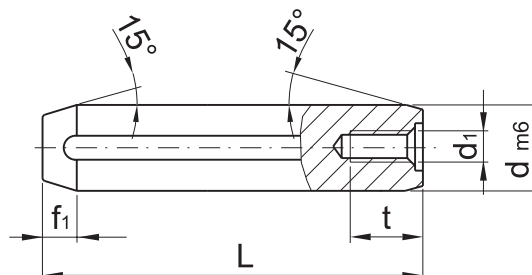

Hartowany  
Hardened 60±2 HRC

d	f1	d1	t	L	NR KAT.
14	4	M8	12	70	KWG-14070
				80	KWG-14080
				90	KWG-14090
				100	KWG-14100
				120	KWG-14120
16	4,7	M8	12	32	KWG-16032
				36	KWG-16036
				40	KWG-16040
				45	KWG-16045
				50	KWG-16050
				55	KWG-16055
				60	KWG-16060
				70	KWG-16070
				80	KWG-16080
				90	KWG-16090
100	KWG-16100				
120	KWG-16120				

d	f1	d1	t	L	NR KAT.
20	6	M10	16	36	KWG-20036
				40	KWG-20040
				45	KWG-20045
				50	KWG-20050
				55	KWG-20055
				60	KWG-20060
				70	KWG-20070
				80	KWG-20080
				90	KWG-20090
				100	KWG-20100
25	6	M16	24	120	KWG-20120
				50	KWG-25050
				60	KWG-25060
				70	KWG-25070
				80	KWG-25080
				90	KWG-25090
				100	KWG-25100
				120	KWG-25120

## Zatrask kulkowy

Ball lock

**ZK**

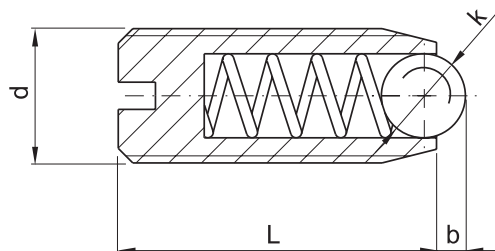

Mat. 1.0503

d	k	L	b	F [N]	NR KAT.
M4	2,5	9	0,8	4 -10	ZK-040
M5	3	12	0,9	6-11	ZK-050
M6	3,5	14	1,0	9-13	ZK-060
M8	5	16	1,5	15-30	ZK-080
M10	6	19	2,0	20-35	ZK-100
M12	8	22	2,5	30-55	ZK-120
M16	10	24	3,5	65-125	ZK-160

## Zatrask

Threaded lock

**ZR**

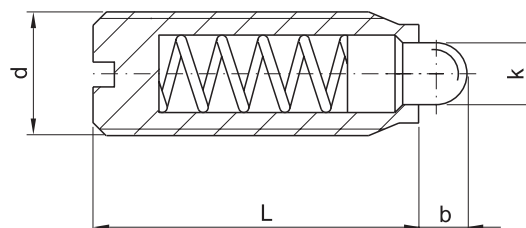

Mat. 1.0503

d	k	L	b	F [N]	NR KAT.
M4	1,8	9	1,5	6-20	ZR-040
M5	2,4	12	2,0	6-20	ZR-050
M6	2,7	14	2,0	7-20	ZR-060
M8	4	16	2,0	15-30	ZR-080
M10	4,5	19	2,5	20-35	ZR-100
M12	6	22	3,5	30-55	ZR-120
M16	8,5	24	4,5	45-100	ZR-160

**Wkręt mocujący**

Set screw

**WK**



DIN 7991  
8.8 (800 N/mm<sup>2</sup>)

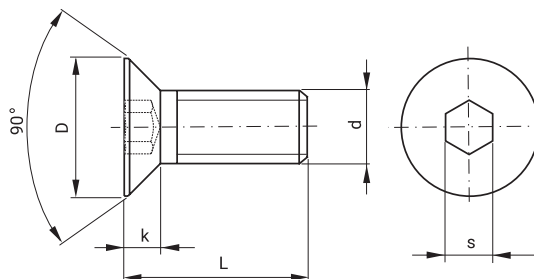

d	L	D	k	s	NR KAT.
M4	8	8	2,3	2,5	WK -0408
	10				WK -0410
	12				WK -0412
	16				WK -0416
	20				WK -0420
M5	8	10	2,8	3	WK -0508
	10				WK -0510
	12				WK -0512
	14				WK -0514
	16				WK -0516
M6	12	12	3,3	4	WK -0612
	16				WK -0616
	20				WK -0620
	25				WK -0625
	30				WK -0630
M8	12	16	4,4	5	WK -0812
	16				WK -0816
	20				WK -0820
	25				WK -0825
	30				WK -0830
M10	20	20	5,5	6	WK -1020
	30				WK -1030
M12	20	24	6,5	8	WK -1220
	30				WK -1230
	35				WK -1235

**Wkręt**

Hexagon socket set screw

**WKA**

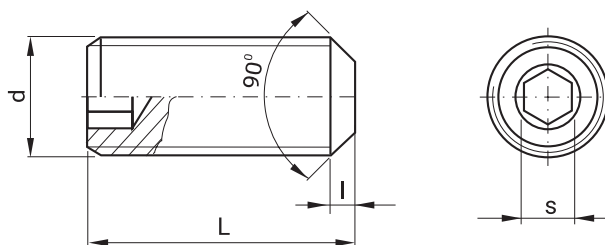

DIN 913-45H

d	s	I	L	NR KAT.
M3	1,5	0,5	6	WKA-0306
			8	WKA-0308
M4	2	0,75	6	WKA-0406
			8	WKA-0408
			10	WKA-0410
			12	WKA-0412
M5	2,5	0,75	6	WKA-0506
			8	WKA-0508
			10	WKA-0510
			12	WKA-0512
M6	3	1	16	WKA-0516
			6	WKA-0606
			8	WKA-0608
			10	WKA-0610
			12	WKA-0612
M8	4	1,25	16	WKA-0616
			20	WKA-0620
			8	WKA-0808
			12	WKA-0812
			16	WKA-0816
M10	5	1,5	20	WKA-0820
			30	WKA-0830
			10	WKA-1010
			12	WKA-1012
			16	WKA-1016
M12	6	1,75	20	WKA-1020
			30	WKA-1030
			40	WKA-1040
			12	WKA-1212
			16	WKA-1216
M16	8	2	20	WKA-1220
			30	WKA-1230
			40	WKA-1240
M16	8	2	20	WKA-1620
			30	WKA-1630
			40	WKA-1640



**Śruba z łbem walcowym**

Socket head cap screw

**SM**

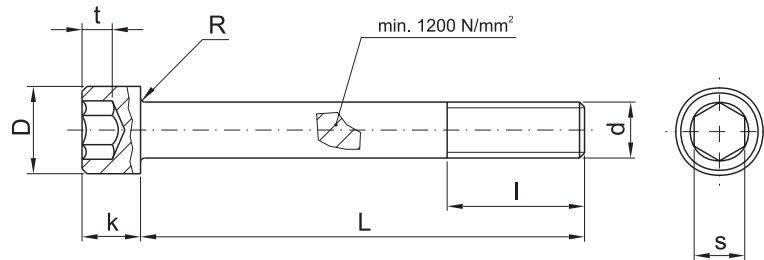

**Klasa** 12.9  
*Class*

d	D	s	k	t	l	R
M4	7	3	4	2	20	0,2
M5	8,5	4	5	2,5	22	
M6	10	5	6	3	24	0,25
M8	13	6	8	4	28	0,4
M10	16	8	10	5	32	
M12	18	10	12	6	38	0,6
M16	24	14	16	8	44	
M20	30	17	20	10	52	0,8
M24	36	19	24	12	60	

L	NR KAT.								
	d								
	M4	M5	M6	M8	M10	M12	M16	M20	M24
16			SM-06016	SM-08016	SM-10016				
20	SM-04020		SM-06020	SM-08020	SM-10020	SM-12020			
25			SM-06025	SM-08025	SM-10025	SM-12025	SM-16025		
30		SM-05030	SM-06030	SM-08030	SM-10030	SM-12030	SM-16030	SM-20030	
35			SM-06035	SM-08035	SM-10035	SM-12035	SM-16035		
40			SM-06040	SM-08040	SM-10040	SM-12040	SM-16040	SM-20040	SM-24040
45			SM-06045	SM-08045	SM-10045	SM-12045	SM-16045	SM-20045	
50			SM-06050	SM-08050	SM-10050	SM-12050	SM-16050	SM-20050	SM-24050
55			SM-06055	SM-08055	SM-10055	SM-12055	SM-16055	SM-20055	
60			SM-06060	SM-08060	SM-10060	SM-12060	SM-16060	SM-20060	SM-24060
65			SM-06065	SM-08065	SM-10065	SM-12065	SM-16065	SM-20065	
70			SM-06070	SM-08070	SM-10070	SM-12070	SM-16070	SM-20070	SM-24070
75			SM-06075	SM-08075	SM-10075	SM-12075	SM-16075		
80			SM-06080	SM-08080	SM-10080	SM-12080	SM-16080	SM-20080	SM-24080
90			SM-06090	SM-08090	SM-10090	SM-12090	SM-16090	SM-20090	SM-24090
100			SM-06100	SM-08100	SM-10100	SM-12100	SM-16100	SM-20100	SM-24100
110			SM-06110	SM-08110	SM-10110	SM-12110	SM-16110	SM-20110	SM-24110
120			SM-06120	SM-08120	SM-10120	SM-12120	SM-16120	SM-20120	SM-24120
130			SM-06130	SM-08130	SM-10130	SM-12130	SM-16130	SM-20130	SM-24130
140			SM-06140	SM-08140	SM-10140	SM-12140	SM-16140	SM-20140	SM-24140
150				SM-08150	SM-10150	SM-12150	SM-16150	SM-20150	SM-24150

# Śruba z łbem walcowym

Socket head cap screw

# SM

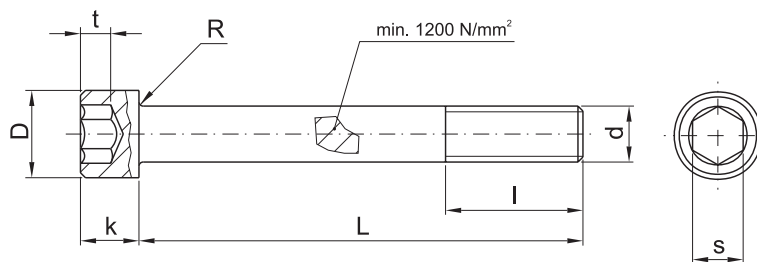

Klasa 12.9  
Class

d	D	s	k	t	l	R
M4	7	3	4	2	20	0,2
M5	8,5	4	5	2,5	22	
M6	10	5	6	3	24	0,25
M8	13	6	8	4	28	0,4
M10	16	8	10	5	32	
M12	18	10	12	6	38	0,6
M16	24	14	16	8	44	
M20	30	17	20	10	52	0,8
M24	36	19	24	12	60	

L	NR KAT.								
	d								
	M4	M5	M6	M8	M10	M12	M16	M20	M24
160			SM-06160	SM-08160	SM-10160	SM-12160	SM-16160	SM-20160	SM-24160
170						SM-12170	SM-16170	SM-20170	
180			SM-06180	SM-08180	SM-10180	SM-12180	SM-16180	SM-20180	SM-24180
190							SM-16190	SM-20190	
200			SM-06200	SM-08200	SM-10200	SM-12200	SM-16200	SM-20200	SM-24200
220				SM-08220	SM-10220	SM-12220	SM-16220	SM-20220	SM-24220
240					SM-10240	SM-12240	SM-16240	SM-20240	SM-24240
260					SM-10260	SM-12260	SM-16260	SM-20260	SM-24260
280					SM-10280	SM-12280	SM-16280	SM-20280	SM-24280
300							SM-16300	SM-20300	SM-24300
320								SM-20320	
340							SM-16340	SM-20340	SM-24340
360									
380							SM-16380		
400									
420							SM-16420		

**Śruba pasowana**

Stripper bolt

**PSM**

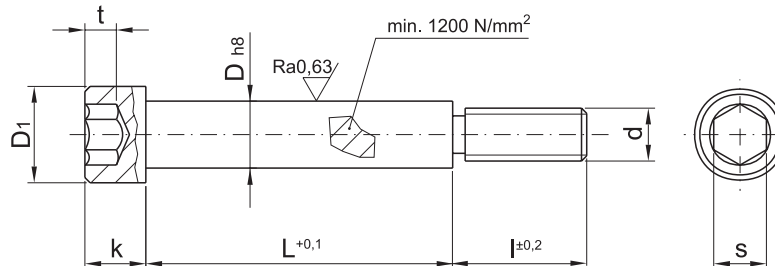

**Klasa** 12.9  
**Class**

d	D	D1	l	k	s	t
M5	6	10	9,5	4,5	3	2
M6	8	13	11	5,5	4	3
M8	10	16	13	7	5	4
M10	12	18	16	9	6	5
M12	16	24	18	11	8	6
M16	20	30	22	14	10	8
M20	24	36	27	16	12	10

L	NR KAT.						
	d						
	M5	M6	M8	M10	M12	M16	M20
10	PSM-05010						
12	PSM-05012	PSM-06012					
16	PSM-05016	PSM-06016	PSM-08016	PSM-10016			
20	PSM-05020	PSM-06020	PSM-08020	PSM-10020			
25	PSM-05025	PSM-06025	PSM-08025	PSM-10025			
30	PSM-05030	PSM-06030	PSM-08030	PSM-10030	PSM-12030		
40	PSM-05040	PSM-06040	PSM-08040	PSM-10040	PSM-12040	PSM-16040	
50		PSM-06050	PSM-08050	PSM-10050	PSM-12050	PSM-16050	PSM-20050
60			PSM-08060	PSM-10060	PSM-12060	PSM-16060	PSM-20060
70			PSM-08070	PSM-10070	PSM-12070	PSM-16070	PSM-20070
80			PSM-08080	PSM-10080	PSM-12080	PSM-16080	PSM-20080
90				PSM-10090	PSM-12090	PSM-16090	PSM-20090
100				PSM-10100	PSM-12100	PSM-16100	PSM-20100
120					PSM-12120	PSM-16120	PSM-20120

## Śruba pasowana z tulejką

Stripper bolt with bushing

# PST

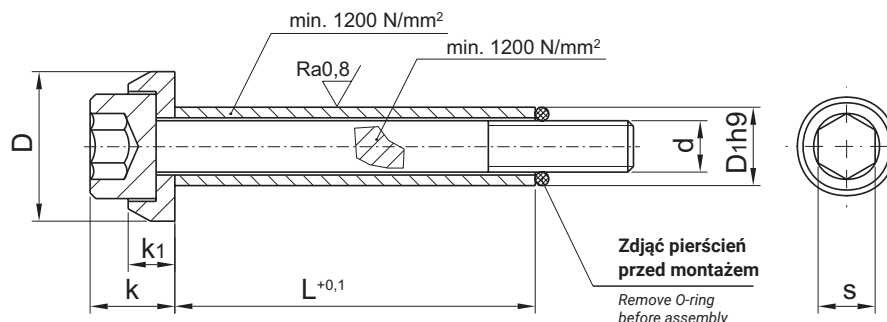

d	D1	s	k	k1	D
M6	10	5	10	5,5	15
M8	12,5	6	13	6,5	19
M10	15	8	15	7,5	23
M12	17,5	10	18	9,0	27
M16	23	14	24	11,0	34

L	NR KAT.				
	d				
	M6	M8	M10	M12	M16
20	PST-06020				
25	PST-06025				
30	PST-06030	PST-08030	PST-10030		
35	PST-06035	PST-08035	PST-10035		
40	PST-06040	PST-08040	PST-10040	PST-12040	
45	PST-06045	PST-08045	PST-10045	PST-12045	
50	PST-06050	PST-08050	PST-10050	PST-12050	PST-16050
55	PST-06055	PST-08055	PST-10055	PST-12055	
60	PST-06060	PST-08060	PST-10060	PST-12060	PST-16060
70	PST-06070	PST-08070	PST-10070	PST-12070	PST-16070
80	PST-06080	PST-08080	PST-10080	PST-12080	PST-16080
90	PST-06090	PST-08090	PST-10090	PST-12090	PST-16090
100		PST-08100	PST-10100	PST-12100	PST-16100
110				PST-12110	PST-16110
120			PST-10120	PST-12120	PST-16120
140				PST-12140	PST-16140
150					PST-16150
160					PST-16160